

PLAN VIEW

Weight of Item

1238 Kilo

Application & Uses

**Drainage
Electrical
Sewerage
Communication**



Quality Drainage Products

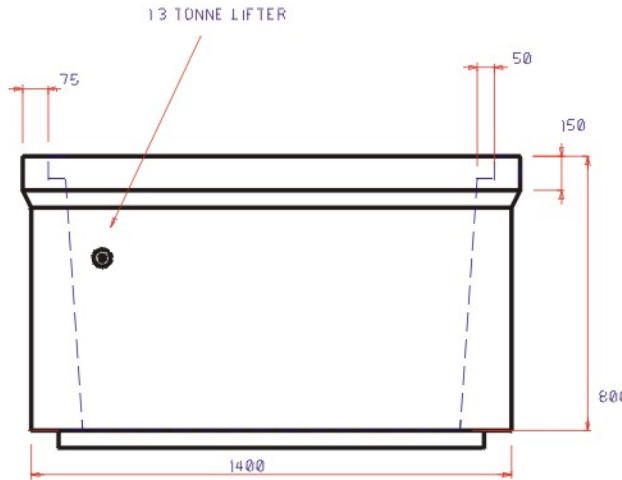

FRONT VIEW

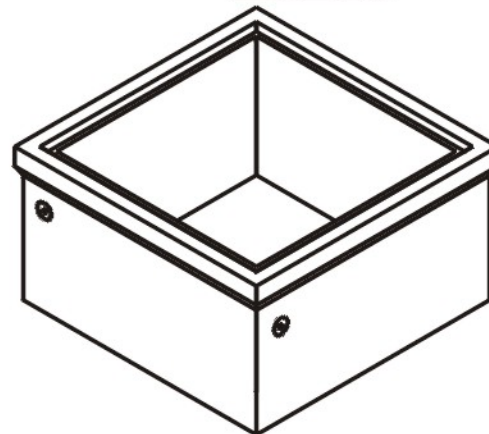

ISOMETRIC VIEW

All WILMAC products are manufactured to comply with the published Australian Standard relating to the application for which they are intended.

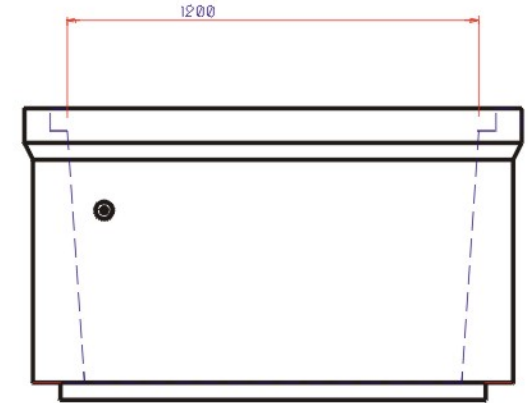

SIDE VIEW

Description of Item

1200x1200x800 Riser

Product Code

128R

WILMAC PTY LTD

ABN 39 002 205 969

40 Burrabogee Road Pendle Hill NSW
phone(02) 9631 0957 fax: (02) 9636 3715
email: sales@wilmac.com.au