

**TOP VIEW**

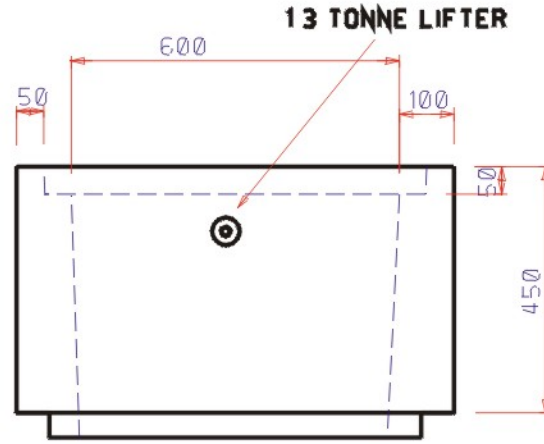

**450 RISER**

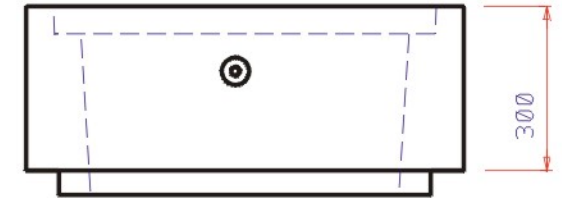

**300 RISER**

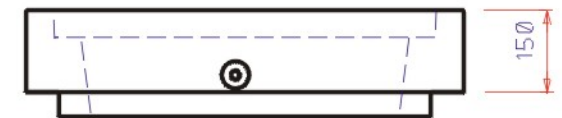

**150 RISER**

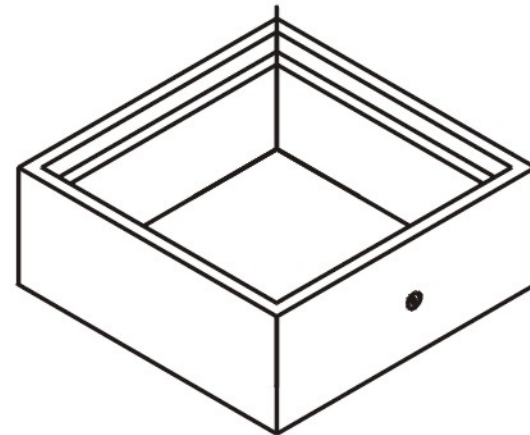

**ISOMETRIC VIEW**

Weight of Item

**203 Kilo**

Application & Uses

**Drainage  
Electrical  
Sewerage  
Communication**



Quality Drainage Products

**All WILMAC products are manufactured to comply with the published Australian Standard relating to the application for which they are intended.**

Description of Item

**600x600x300 Riser**

Product Code

**663R**

**WILMAC PTY LTD**

ABN 39 002 205 969

40 Burrabogee Road Pendle Hill NSW  
phone(02) 9631 0957 fax: (02) 9636 3715  
email: sales@wilmac.com.au