

TOP VIEW

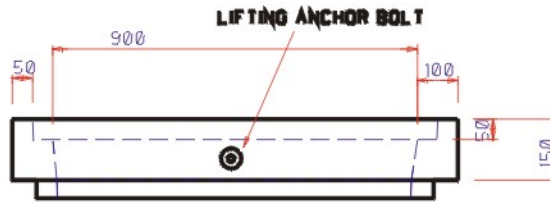

FRONT VIEW

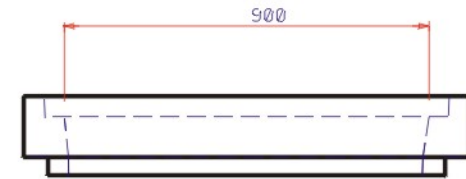

SIDE VIEW

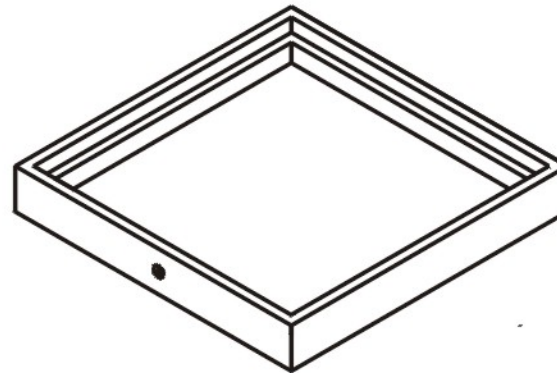

ISOMETRIC VIEW

Weight of Item

158Kilo

Application & Uses

**Drainage
Electrical
Sewerage
Communication**



Quality Drainage Products

All WILMAC products are manufactured to comply with the published Australian Standard relating to the application for which they are intended.

Description of Item

900x900x150 Riser

Product Code

991R

WILMAC PTY LTD

ABN 39 002 205 969

40 Burrabogee Road Pendle Hill NSW
phone(02) 9631 0957 fax: (02) 9636 3715
email: sales@wilmac.com.au