

TOP VIEW

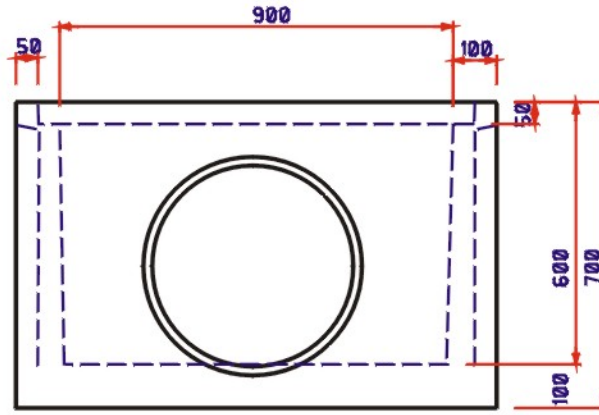

FRONT VIEW

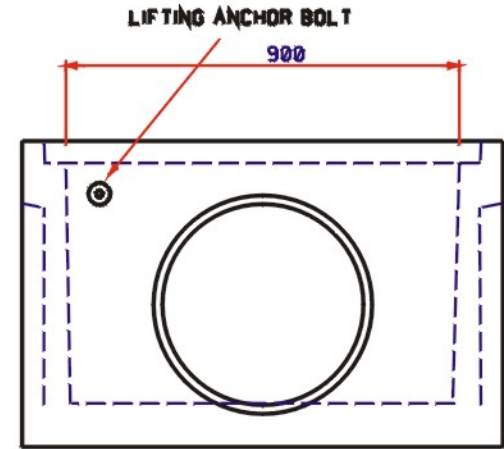

SIDE VIEW

Weight of Item

**880 Kilo**

Application & Uses

**Drainage  
Electrical  
Sewerage  
Communication**

**450 Max. Pipe**

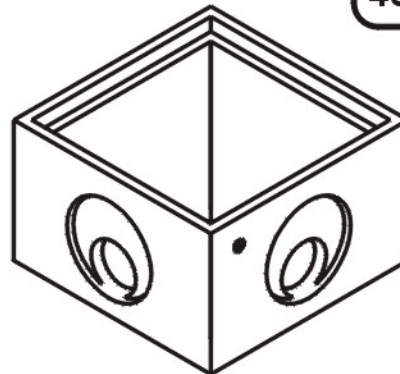

ISOMETRIC VIEW

Description of Item

**900x900x600 Pit Base**

Product Code

**996P**

**WILMAC PTY LTD**

ABN 39 002 205 969

40 Burrabogee Road Pendle Hill NSW  
phone(02) 9631 0957 fax: (02) 9636 3715  
email: sales@wilmac.com.au

**All WILMAC products are manufactured to comply with the published Australian Standard relating to the application for which they are intended.**



Quality Drainage Products